

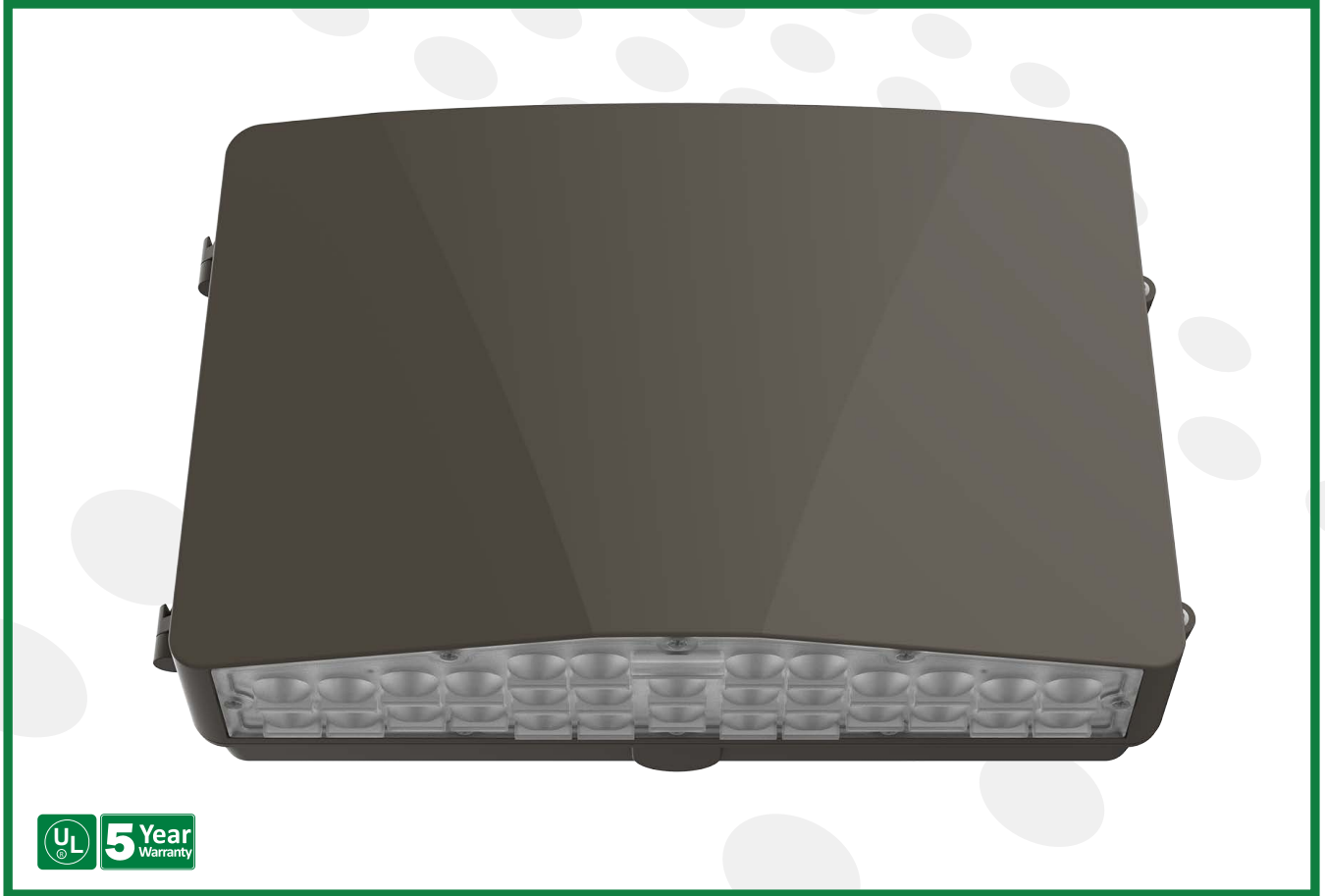

ZION™



Beyond LED's ZION wall pack is the newest, most innovative and feature rich product of 2021. Its unique and sleek design offers three wattages and CCT selection. Zion comes with energy-efficient LED technology and has Built-in photocell. ZION luminaires comes with die cast aluminum housings and a polycarbonate lens to stand up for many years of punishing environmental conditions.

Product Features

- High Efficiency 3030 Chips
- Up to 110 lumens per watt
- Three selectable wattages
- Three selectable CCT
- Built-in photocell
- Durable die-cast aluminum housing with dark bronze powder coat finish
- Rated IP65 with sealed and gasketed wire way enclosure provides a water-tight seal
- Universal 120-277Vac
- UL & DLC Listed
- 5 years warranty.



SKU #	Model #	Watt	Lumens	CCT	IP	Dimming	Housing	Input Voltage	Certifications
154344	ZPS-MB422-100W.V1-T1-E9-P3	Adjustable 100W/80W/60W	11000Lm	3K/4K/5K	IP65	0-10V	Bronze	120-277Vac	UL & DLC

SKU Number 154344 Specifications

Parameter	Description	Value
General Performance	Model #	ZPS-MB422-100W.V1-T1-E9-P3
	Wattage Adjustable	100W/80W/60W
	Lumen	11000Lm
	Lumen Efficacy	Up to 110LM/W
	Color Temperature	3K/4K/5K
	CRI (Ra)	≥70
	Beam Angle	150° x 60° ± 10°Degree
	Diffuser Type	PC Lens
Electrical	Input Voltage	120-277Vac
	Frequency	50/60Hz
	Dimming	0-10V
	Power Factor	≥0.9
	Flicker Percent	≤30%
	Driver Brand	N/A
	Driver Model	N/A
	Driver Surge Protection	4KV(L-N);6KV(L/N-G)
Physical	Operating Temperature	-40 +40 °C
	Operating Humidity	10% - 80%RH
	Storage Temperature	- 30 + 70 °C
	Storage Humidity	10% - 90%RH
	LED Brand	Lightsource
	LED Type	3030
	LED QTY	120
Qualification	Housing Material	Die-Cast Aluminum
	Housing Color	Bronze
	IP Rating	IP65
	Warranty	5 Years



ZION™

Correlated Color Temperature (CCT)

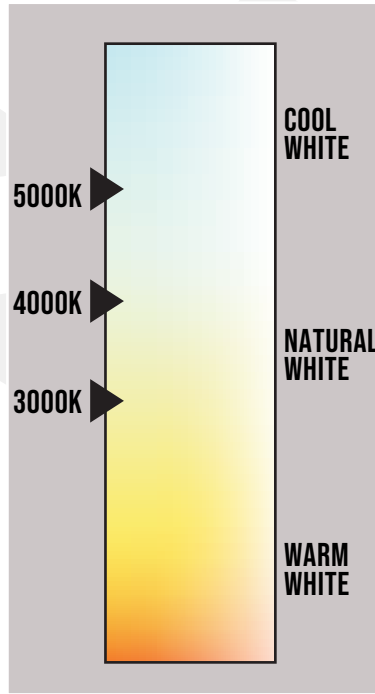

Dimensions

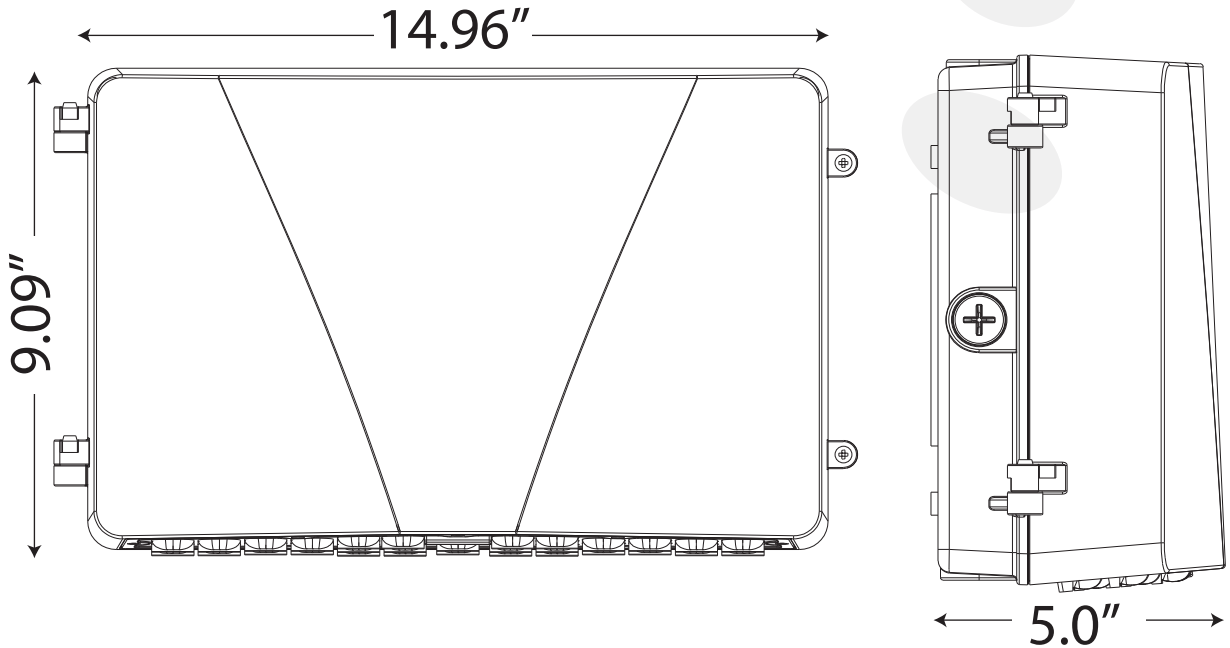

FULL CUT-OFF WALL PACK



LIGHT DISTRIBUTION CRUVE/SPOT

150° x 60° ± 10°
120W: 100° ± 10

LUMINOUS INTENSITY DISTRIBUTION DIAGRAM

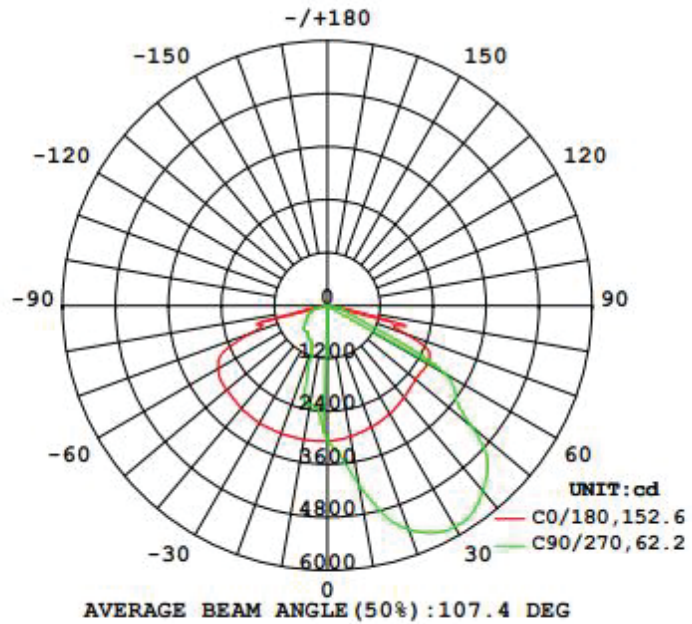

PACKAGE

SKU #	Carton (Inch)	Qty / Carton	Net Weight / Carton	Gross Weight / Carton
154344	15.35x15.51x5.31	1PC		



Installation

SAVE THESE INSTRUCTIONS READ THOROUGHLY BEFORE INSTALLATION

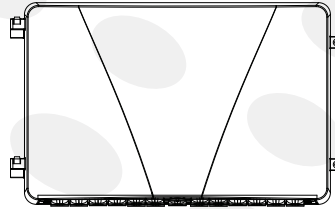

WARNING! Fixtures must be grounded and installed in accordance with the National Electrical Code and all local codes. Failure to do so may increase the **RISK OF PERSONAL INJURY, PROPERTY DAMAGE, FIRE AND DEATH**. Install and use so fixture failures do not cause a hazard and use only in environments for which the product is specifically marked.

WARNING! This product can expose you to chemicals including lead and lead compounds, which are known to the State of California to cause cancer and birth defects or other reproductive harm. For more information, go to: www.P65Warnings.ca.gov

WARNING! Dangerous voltage exist within the unit and all precautions usually observed in handling high voltage equipment should be observed when replacing light engine or otherwise servicing luminaires. Disregarding this warning could result in electrical shock and possible injury to the individual installing or servicing this equipment. Installation and servicing should be done by qualified personnel.

CAUTION! Follow ALL luminaire recommendations, product markings, instructions, restrictions and warnings regarding luminaire operation and burning position. Luminaire label shows electrical and environmental requirements and restrictions.

NOTE! This luminaire is designed for outdoor lighting applications with ambient temperatures not exceeding 40°C (104°F).

All electrical work must be done by a qualified electrician.

Turn off electric power to all affected circuits and allow to cool before installation or servicing.

A regularly scheduled maintenance program should be established to retain optimum light output and reduce heat retention. Dusting with a soft, clean, dry cloth is normally sufficient for the optical system. Any accumulation of dust or dirt should be removed regularly.

Carefully read these instructions before installing product.

Give instructions to facility owner/manager for future reference.

Mounting The Fixture

Tools Required: Phillips screwdriver

- Turn off power to electrical connections.
- Wiring must be performed by a qualified electrician.
- Make electrical connections according to the local and National Electrical Codes.
- This product is suitable for 120V to 277V wiring.
- Remove fixture from packaging along with hardware bag that contains a junction box gasket and wire nuts.
- Remove 1/2" plug in center (B) for wiring. The fixture supports standard 3 1/4" and 4" junction box.
- Mounting of fixture can be achieved by one of the methods below (see figure 1):
 - Drill the junction box cast detail and use 10-24 screws (provided by others) driven into the 3.5" or 2.75" holes.
 - Or drill the C-Location holes and use fasteners (provided by others).
- Install the fixture on the wall making sure to use the provided junction box gasket to protect from water. Fixture should be oriented as shown in pictures at the top of this instruction page.
- Finish wiring the fixture. There are 5 wires provided. Black wire (line voltage). White wire Neutral). Green or bare copper wire (ground). Grey/Pink wire is DIM (-) (0-10VDC dimming) if dimming is not desired cap this wire. Purple wire is DIM (+) (0-10VDC dimming) if dimming is not desired cap this wire.

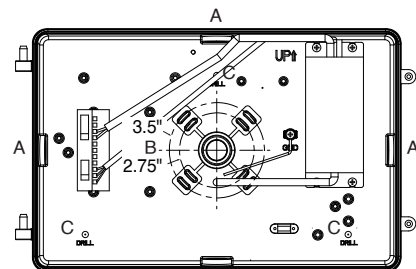
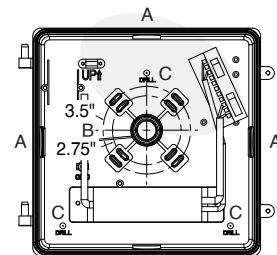

FIGURE 1



Installation

Black	○	Line
White	○	Neutral
Green	○	Ground
Purple	○	DIM+
Grey/Pink	○	DIM-

- A - 1/2" NPS tapped holes (surface conduit or photo control)
- B - 1/2" NPS tapped holes
- C - Drill hole locations

**SAVE THESE INSTRUCTIONS
READ THOROUGHLY BEFORE INSTALLATION**

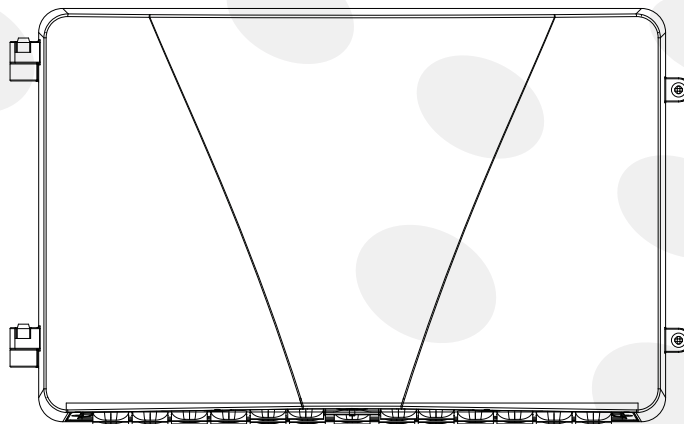

LUMEN SELECTABLE INSTRUCTIONS

Different lumen levels can be achieved by setting the controller to the positions shown below.

Model	Rated Wattage (H / M / T)	CCT	Luminous Flux
ZPS-MB422-100W.V1-T1-E9-P3	100W/80W/60W	3000K/4000K/5000K	11000Lm



ZION™

Application Picture



Warranty

5 Years Warranty